

TM-CB4D-560-2500WAI
AC MOTOR FAN
EXT ROTOR.

DATASHEET-
INSTALLATION GUIDE.

En-GB
METRIC.
Al Series



TRANSMONK
simply precise.

1.0 Introduction

The specification describes the standards, operating environment, and technical requirements of the product.

2.0 Requirements of product standards and safety regulations

2.1 Standards and requirements of the product followed

2.1.1 GB12350 (Safety requirements of small power motors)

2.1.2 EN60335-1 (Safety requirements of household and similar electrical appliances)

2.2 The fan is CCC and CE approved.

2.3 All materials are ROHS compliant

3.0 Mechanical requirements

3.1 Motor magnetic materials

QZ-2 180 degree Celsius / High Strength enamelled wire QZ-2 180 degree Celsius

Stator and Rotor permeability magnetic material: Silicon Steel

Rotor: Die-Casting Aluminium

3.2 Balancing: The residual unbalance weight is less than the permit value of G6.3 (balancing precision grade, according to the standard of JB/T9101) when the fan is running at rated voltage and frequency.

3.3 Vibration: Vibration speed virtual value of fans accord with JB/T8689.

3.4 Lifespan: The fan is designed to run for a lifespan of 30,000~40,000 hours when the fan is running at rated voltage, rated load and maximum operating temperature.

4.0 Electrical Protection: The motor is equipped with the overload protection function, cut off temperature is between 150-160 degrees Celsius and reset temperature is between 90-120 degree Celsius

Leakage current: According to GB 12350

Installation mode: Horizontal & Vertical

Mode of speed regulation: Please provide the controller details with which you want to regulate the fan speed

5.0 Quality requirements

Quality requirements in accordance with ISO9001:2000 and inhouse quality standards

6.0 Operating and storing environmental requirements

Operating temperature range: -30 to +60 degree Celsius

Operating humidity range: 0% to 90% RH

Operating altitude: \leq 1000 m

Ambient atmospheric pressure: 80-110 Kpa

Transportation/Storing temperatures range: -40 ~ +80 degree Celsius

Transportation/Storing humidity range: 0% ~ +75% RH

Packaging: Carton / Wooden packing

7.0 Standard of noise test: As per ISO 13347 (Determination of fan sound power levels under standardized laboratory conditions)

Product specification

Nominal data

Fan model	TM-CB4D-560-2500WAI
Motor type	AC external rotor
Power Supply	3 ~ 400 Volt
Voltage range	360 ~ 440
Frequency	50Hz
Input power	2500 Watts
Capacitor	NA
Speed	1340 RPM
Current	4.5 Amp
Airflow@0 pa	12100 CMH
Sound power	81db
Impeller type	Backward curve

Technical data

Protection class	IP54
Thermal class	F (155 degree)
Fan life*	~ 30,000 to 40,000 hours
Weight	30 Kg
Rotation direction	Clockwise, viewed toward rotor
Certification	CE
Impeller material	Aluminium
Rotor	Die-casting Aluminium
Bearing	Maintenance free ball bearing

Product specification

Technical data

Installation mode	Horizontal / Vertical
Control method	TM AC Fan speed controller
Power output	NA
Tach output	NA
Inbuilt protection	Thermal overload relay

*If the fan is running continuously at rated voltage, rated load and maximum operating temperature

Drawing (all dimensions are in mm)

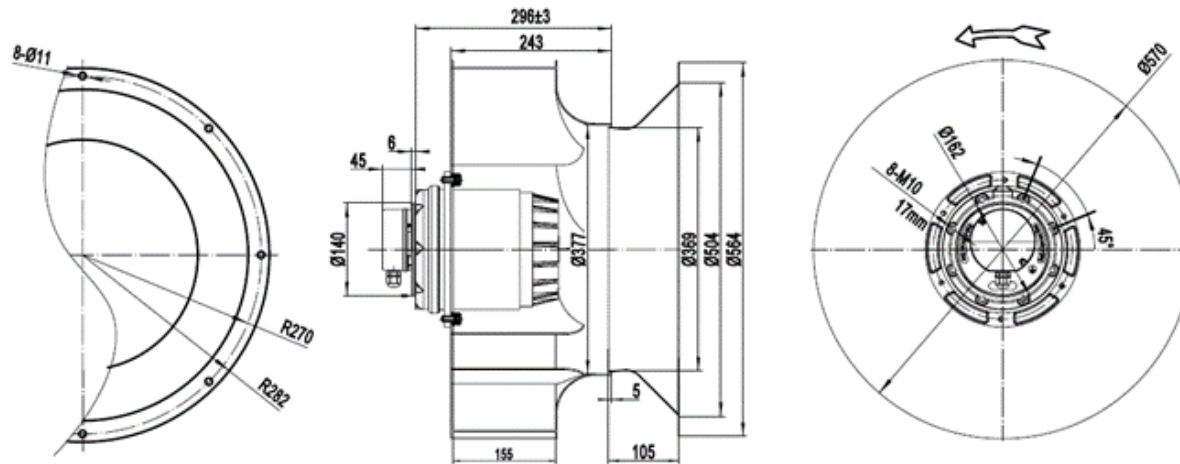

Performance curve

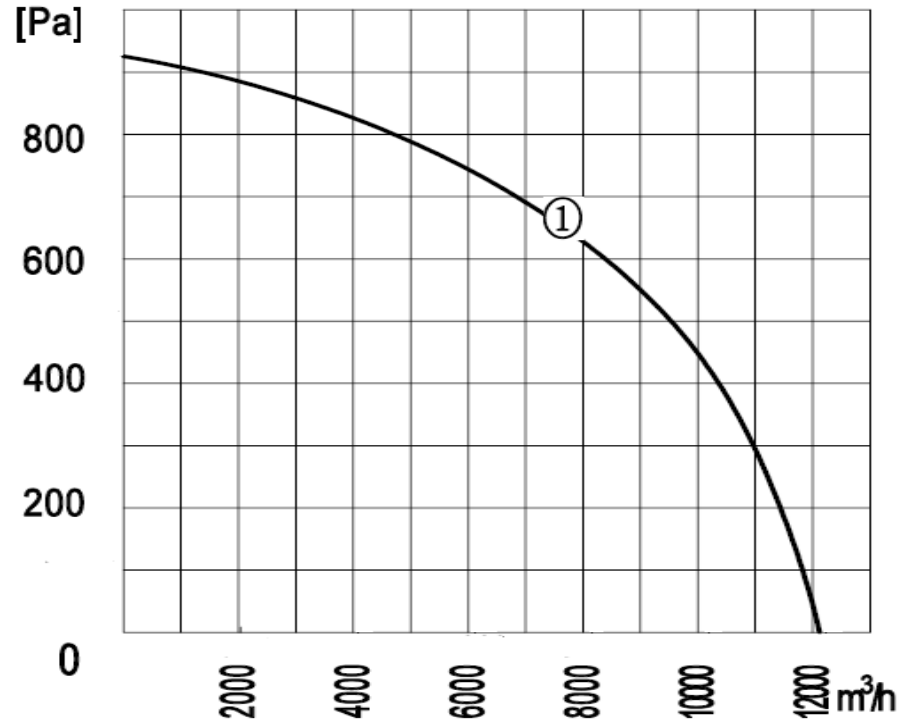

Data point table

Point	RPM	Power(watt)	Current (Amp)	Airflow (CMH)	Pressure (Pa)
1	1400	2500	4.5	12100	0

Wiring Diagram (Three Phase)

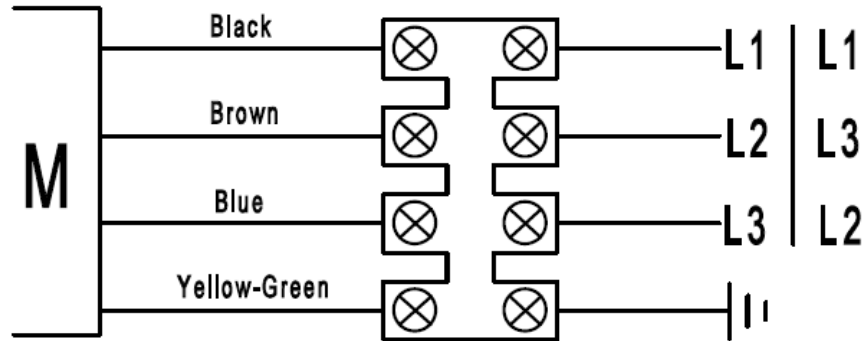

Important Note

Cannot be used in coal mines where methane mixed gas and coal dust may cause explosion hazard.

Keep away from rotating parts when the fan is in running condition.

Cannot be placed and used in places where corrosive gas or steam is present.

Do not touch any of the high voltage line when the product is powered on.

The bearings used are ball bearings so please prevent the rotor from direct impact.

In order to avoid the circuit from breakdown OR insulation from damage, do not pull the wire harness while moving the product.

Customer fan unit should connect to ground well.

Do not touch the fan blade in running condition

Please use the fan under the conditions specified in this datasheet and contact us in case of any queries